

Date rev. Description

V 1.0

House	3409781 Münster 3	Sheet	1
Drawing	3D	Scale	
Material	34X135	Date	06.12.2023
Drawer	K.K.	File	3409781 Münster 3 3D.dwg

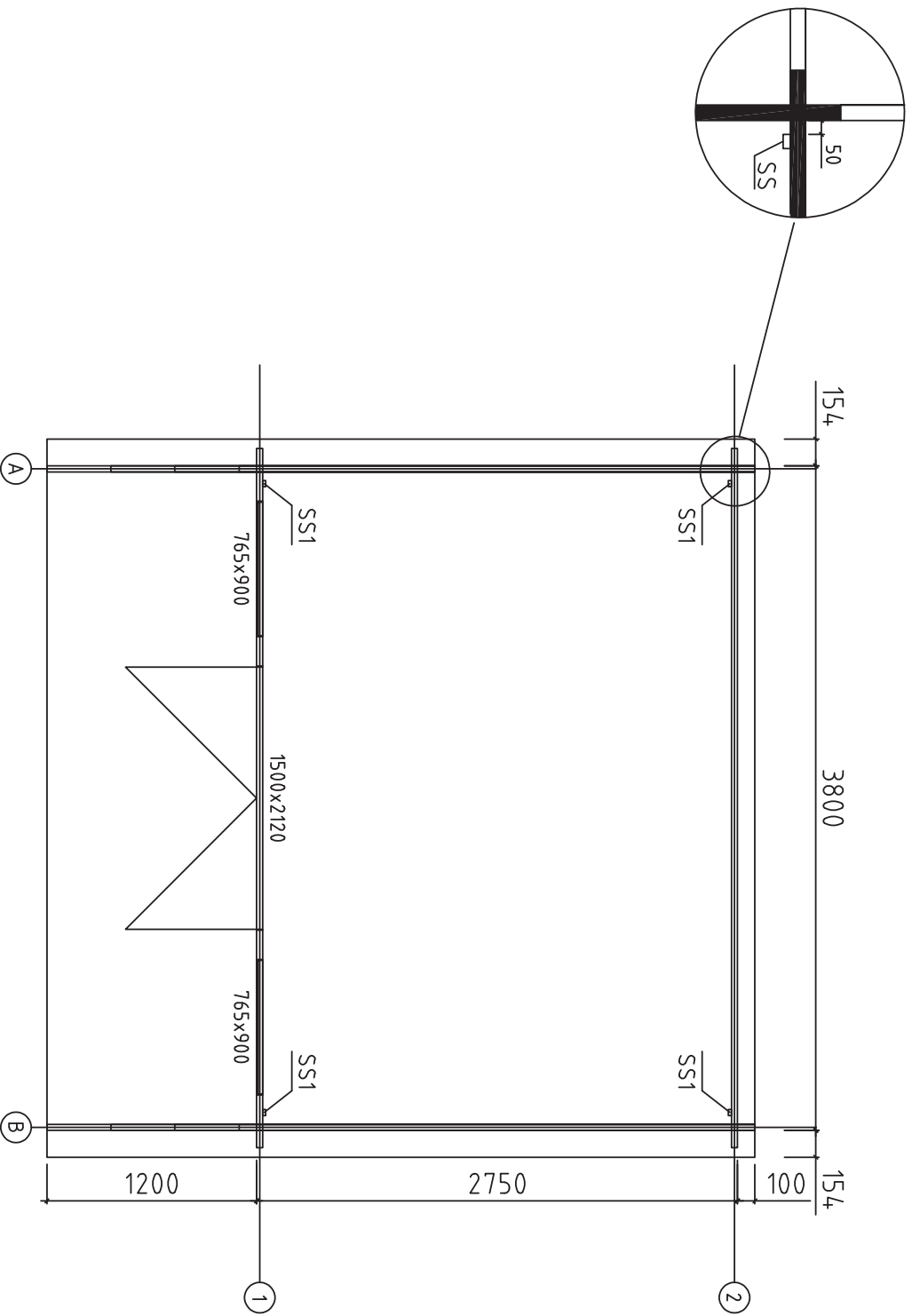

Kood	3409781 Münster 3	Leht	2
Joonis	Plan	Muutkava	1:35
Materjal	34x135	Kuup	06.12.2023
Joonistas	K.K.	File	3409781 Münster 3.dwg

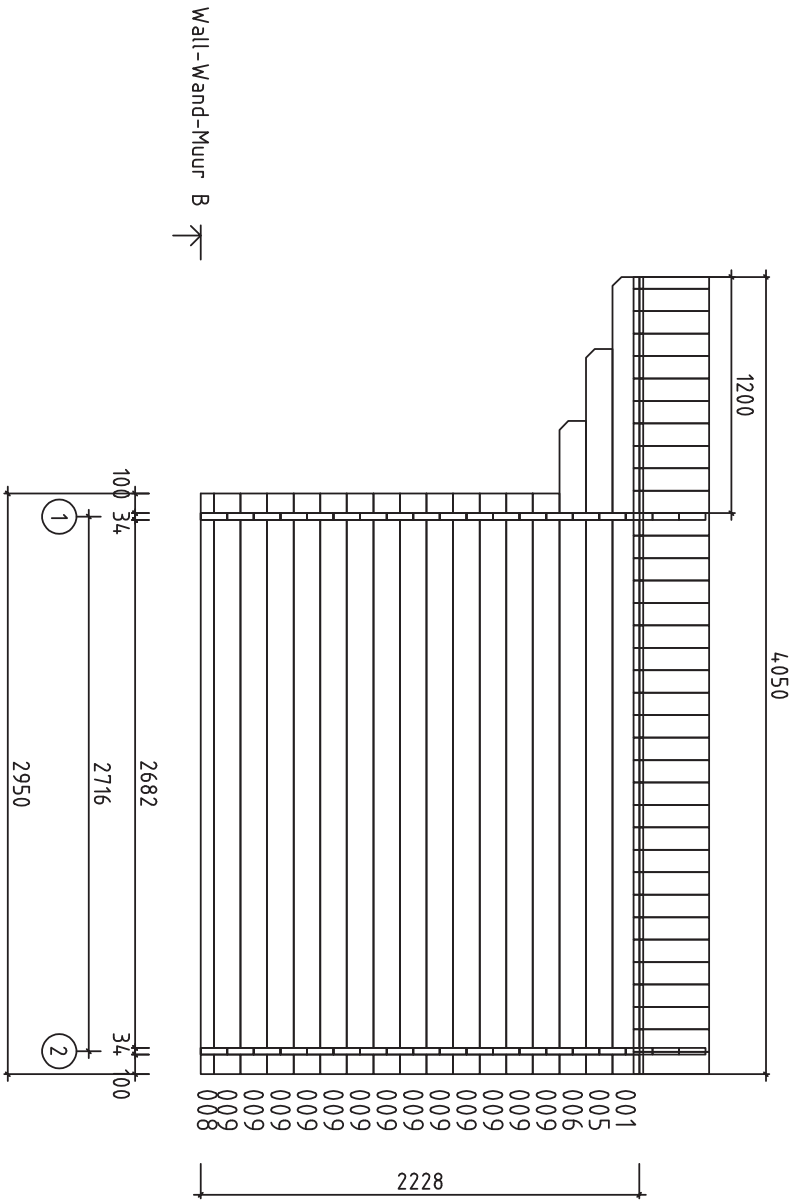



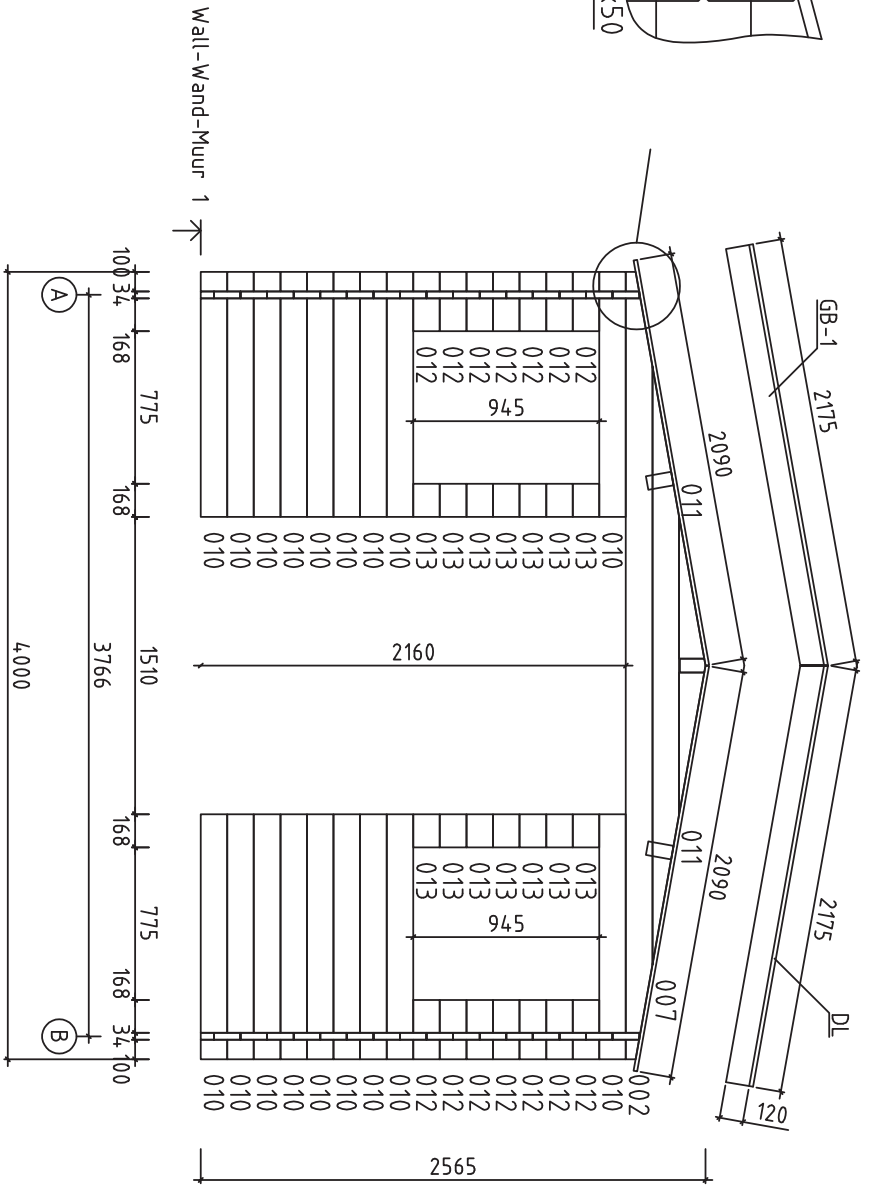
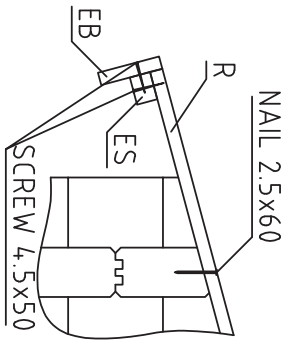



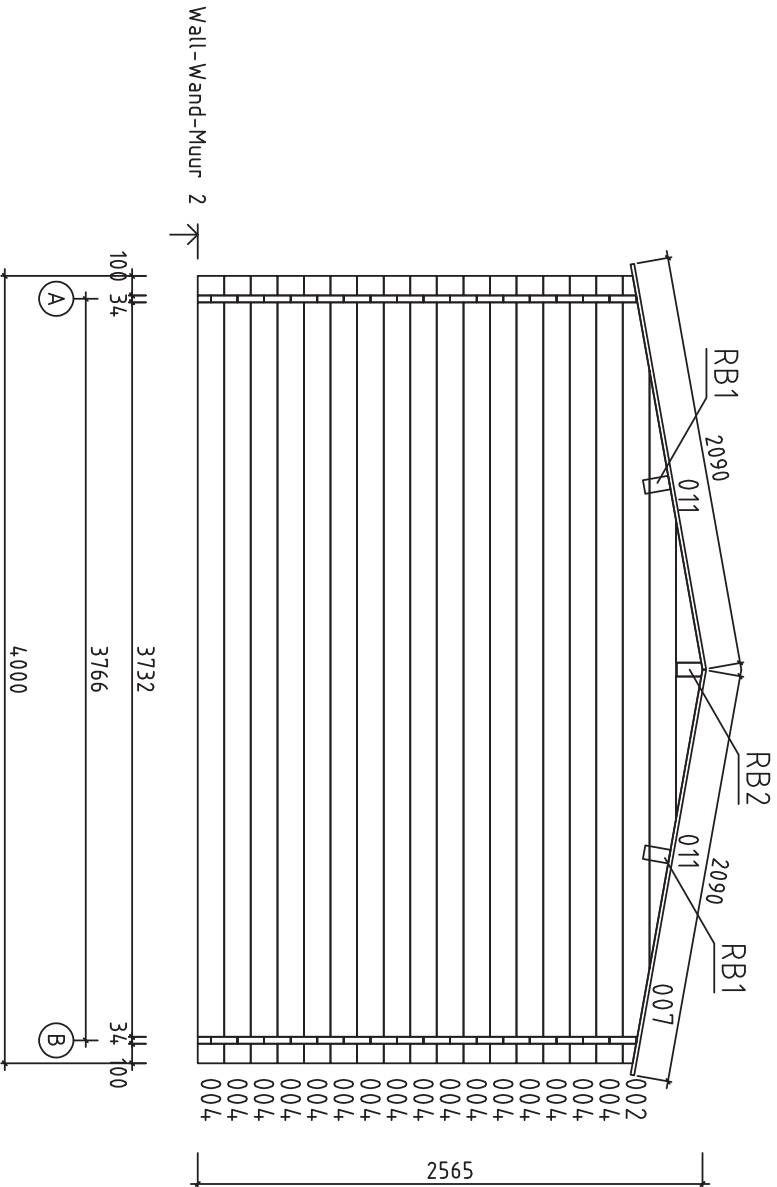



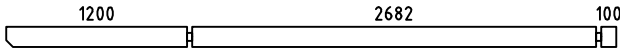
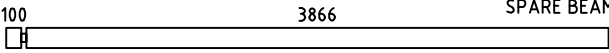
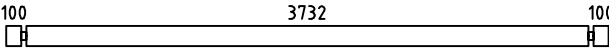
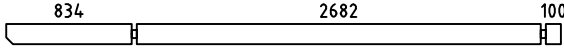
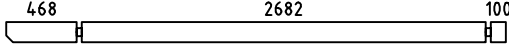
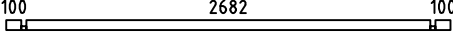
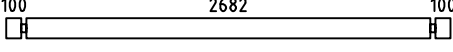
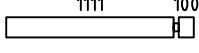

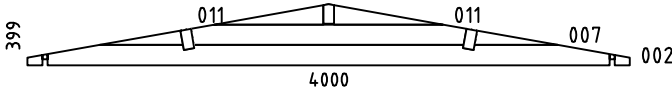
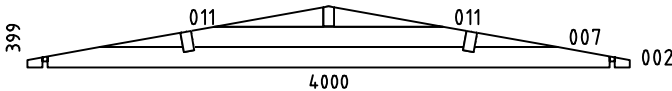
Kood	3409781 Münster 3	Leht	4
Joonis	WALL-WAND-MUUR B	Mohtava	1:35
Materjal	3.4x13.5	Kuup	06.12.2023
Joonestas	K.K.	File	3409781 Münster 3.dwg

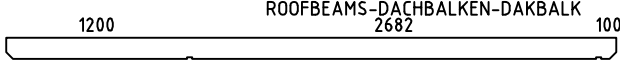
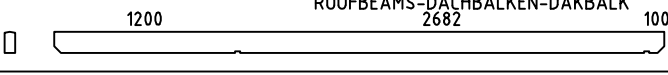

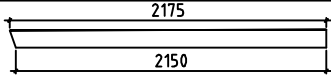







Koed	3409781 Münster 3	Leht	5
Joonis	WALL-WAND-MUUR 1	Muutkava	1:35
Materjal	3.4x13.5	Kuup	06.12.2023
Joonestas	K.K.	File	3409781 Münster 3.dwg

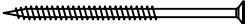
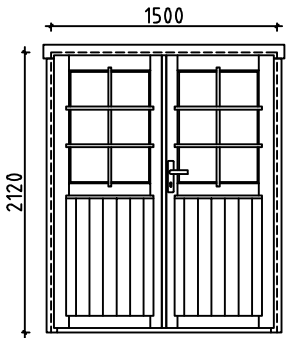
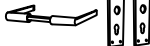

Kood	3409781 Münster 3	Leht	6
Joonis	WALL-WAND-MUUR 2	Mohtava	1:35
Materjal	3.4x13.5	Kuup	06.12.2023
Joonestas	K.K.	File	3409781 Münster 3.dwg

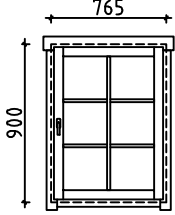
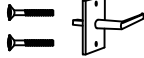
Pos	Specification-Bestimmung-Omschrijving	Pcs	Profile (mm)	L (mm)		
001	 PM	2	34x135	4050		
003	 SPARE BEAM-ERZATZBOHLE-VOORRAADPLANK	1	34x135	4000		
004	 16	16	34x135	4000		
005	 2	2	34x135	3684		
006	 2	2	34x135	3318		
008	 2	2	34x68	2950		
009	 26	26	34x135	2950		
010	 18	18	34x135	1245		
012	 14	14	34x135	302		
013	 14	14	34x135	168		
W1-1	 1	1	34x399	4000		
W2-1	 1	1	34x399	4000		
HB	HIT BLOCK-SCHLAGHÖLZER-BLAZENPLANK  2	2	34x135	300		
RB1	 ROOFBEAMS-DACHBALKEN-DAKBALK 2	2	70x140	4050		
RB2	 ROOFBEAMS-DACHBALKEN-DAKBALK 1	1	70x140	4050		
R1	ROOFBOARD-DACHBRETT-DAKPLANK  or-oder-of 	72+2 94+2	18x114 18x88	2090		
GB1	GABLE BOARD-GIEBELBLENDE-GEVELPLANK  4	4	18x120	2175		
GS1	ROOF FELT FILLET-GIEBELLEISTE-GEVELLIJST  4	4	18x70	2175		
EB1	EAVE BOARD-TRAUFBRETT-AFDEKPLANK  2	2	18x90	4050		
ES1	EAVE SLAT-TRAUFENLEISTE-AFDEKLIJST  4	4	30x40	2025		
DB1	DIAMOND-RAUTE-DIAMANT  2	2	18x90	200		
SS1	STORM SLAT-STURMLEISTE-STORMLIJST  4	4	18x35	2150		
	SCREWS-SCHRAUBEN-SCHROEF FOR-FÜR-VOOR SS1  12	12	φ6.0	50		
Kood	3409781 Münster 3	Materjal	File	3409781 Münster 3.dwg	Leht	7

Pos	Specification-Bestimmung-Omschrijving	Pcs	Profile (mm)	L (mm)		
	WASHER-SCHEIBE-SCHIJF FOR-FÜR-VOOR SS1 	12	∅6.0	18		
	NAIL-NAGEL-NAGEL FOR-FÜR-VOOR R1 	430	∅2.5	60		
	SCREWS-SCHRAUBEN-SCHROEF FOR-FÜR-VOOR GB1, GS1, EB1, ES1, DB1 	86	∅4.5	50		
	SCREWS-SCHRAUBEN-SCHROEF FOR-FÜR-VOOR RB1, RB2 	6	∅6.0	160		
	DOUBLEDOR-DOPELTÜR-DUBBELE DEUR (right-rechts-rechts) AST_ISO_PL P   1  1  1  6  2	1	1500	2120		
	WINDOW-FENSTER-VENSTER (1x right-rechts-rechts; 1x left-links-links) AST_ISO_KP   2  2	P+V 1+1 2 2	765	900		
Kood	3409781 Münster 3	Materjal	File	3409781 Münster 3.dwg	Leht	8